

ABSR1510

1.5AMP GLASS PASSIVATED FAST BRIDGE RECTIFIERS

FEATURE

- . Glass passivated junction.
- . Ideal for printed circuit board.
- . Reliable low cost construction utilizing molded plastic technique.
- . High surge current capability.
- . High temperature soldering guaranteed: 260°C/10 seconds at terminals.
- . Small size, simple installation.

MECHANICAL DATA

- . Case: Molded plastic
- . Epoxy: UL 94V-0 rate flame retardant
- . Lead: MIL-STD- 202E, Method 208 guaranteed
- . Polarity: As marked

ABS

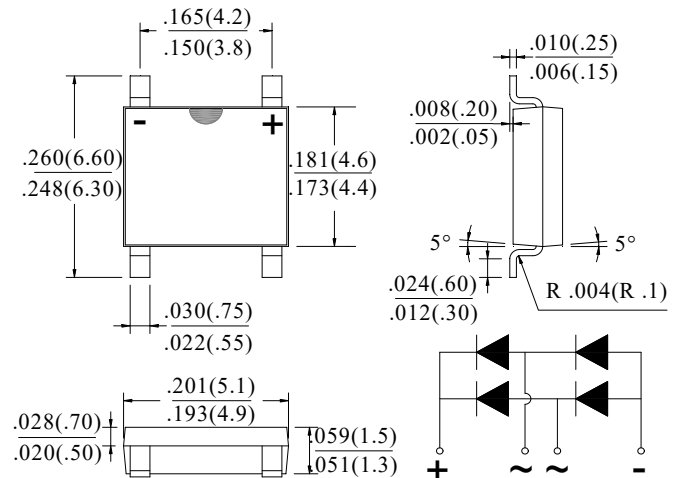

Dimensions in inches and (millimeters)

MAXIMUM RATINGS AND ELECTRICAL CHARACTERISTICS

Ratings at 25°C ambient temperature unless otherwise specified.

Single phase, half wave, 60Hz, resistive or inductive load. For capacitive load, derate current by 20%

| Type Number | SYM BOL | ABSR1510 | units |
|--|-------------|--------------|---------------------------|
| Maximum Recurrent Peak Reverse Voltage | V_{RRM} | 1000 | V |
| Maximum RMS Voltage | V_{RMS} | 700 | V |
| Maximum DC blocking Voltage | V_{DC} | 1000 | V |
| Maximum Average Forward rectified Current | $I_{F(AV)}$ | 1.5 | A |
| Peak Forward Surge Current times at 8.3ms single half sine-wave superimposed on rate load (JEDEC method) | I_{FSM} | 40 | A |
| Maximum Forward Voltage at 1.5A DC | V_F | 1.3 | V |
| Maximum DC Reverse Current @ $T_J=25^\circ\text{C}$ at rated DC blocking voltage @ $T_J=125^\circ\text{C}$ | I_R | 5.0 200.0 | μA |
| Maximum Reverse Recovery Time (Note 1) | T_{rr} | 500 | nS |
| I^2t Rating for Fusing ($t < 8.3\text{ms}$) | I^2t | 6.64 | A^2Sec |
| Typical Junction Capacitance Per Leg (Note2) | C_J | 14 | pF |
| Typical Thermal Resistance (Note3) | R_{JA} | 65 | $^\circ\text{C}/\text{W}$ |
| | R_{JC} | 22 | |
| Storage Temperature | T_{STG} | -55 to +150 | $^\circ\text{C}$ |
| Operating Junction Temperature | T_J | -55 to +150 | $^\circ\text{C}$ |

Note:

1. Test Conditions: $I_F=0.5\text{A}$, $I_R=1.0\text{A}$, $I_{RR}=0.25\text{A}$
2. Measured at 1.0 MHz and applied reverse voltage of 4.0Vdc
3. Thermal Resistance from Junction to Ambient mounted on P.C.B with $0.2 \times 0.2''$ ($5 \times 5\text{mm}$) copper pads

RATING AND CHARACTERISTIC CURVES

FIG.1-TYPICAL FORWARD CURRENT DERATING CURVE

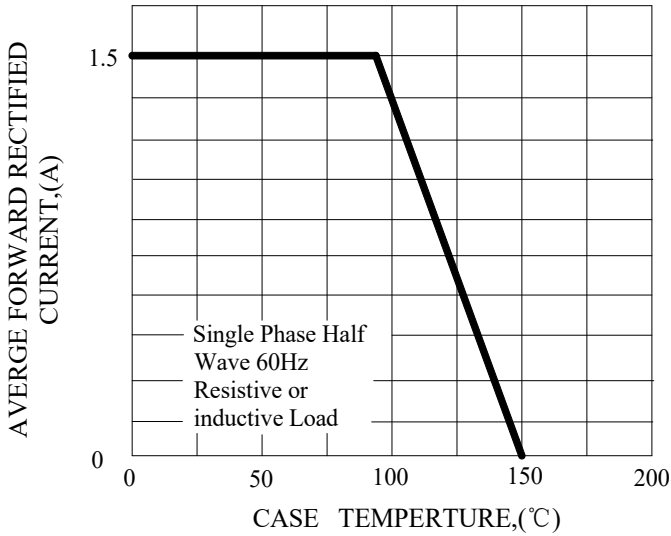

FIG.2-TYPICAL INSTANTANEOUS FORWARD CHARACTERISTICS

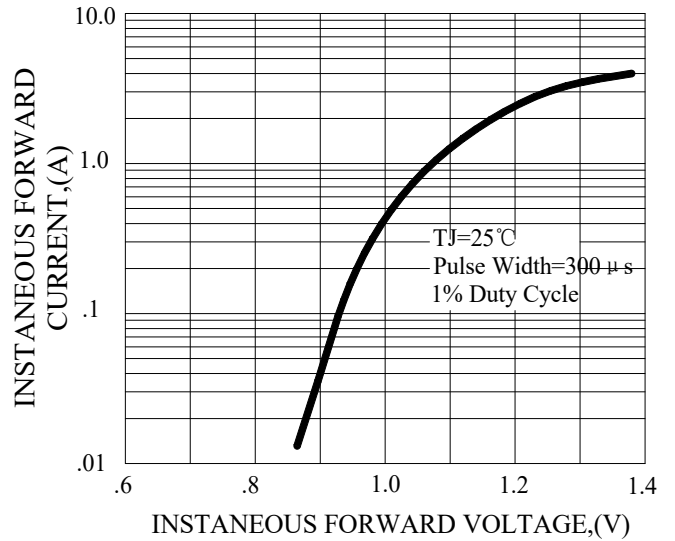

FIG.3-MAXIMUN NON-REPETITIVE FORWARD SURGE CURRENT

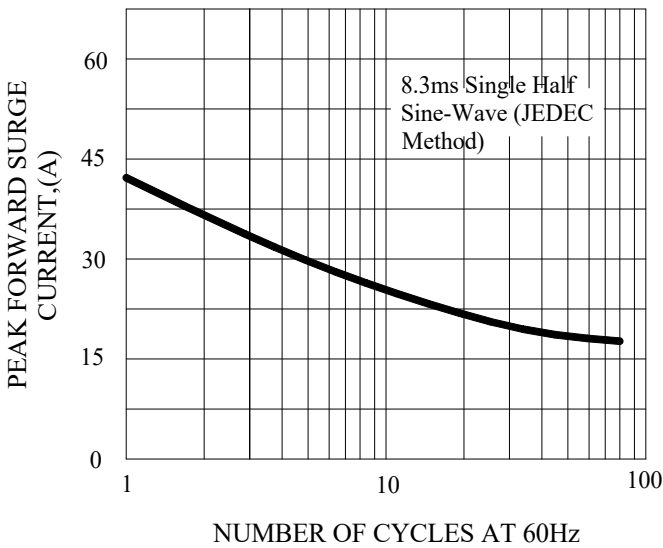

FIG.4-TYPICAL REVERSE CHARACTERISTICS

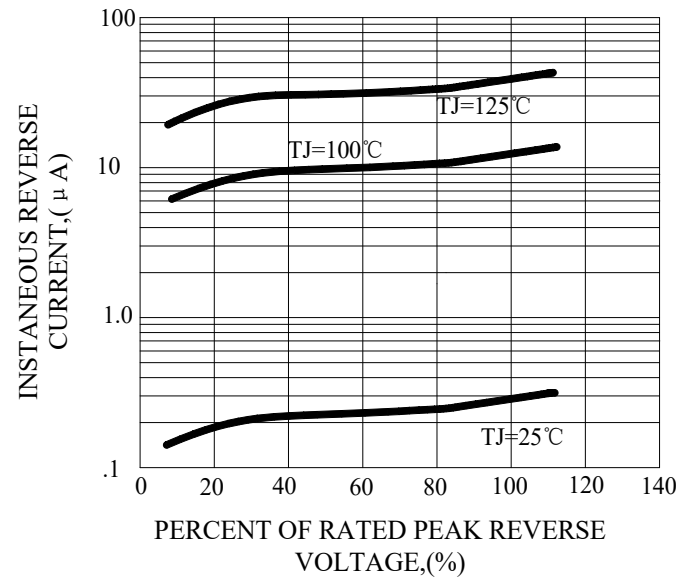
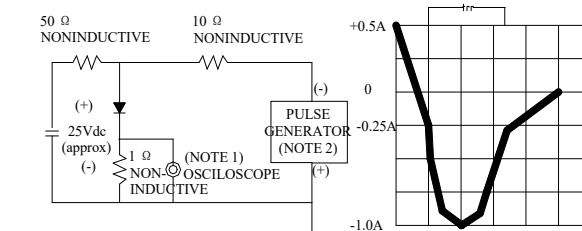

FIG.5-TEST CIRCUIT DIAGRAM AND REVERSE RECOVERY TIME CHARACTERISTIC



NOTES: 1. Rise Time=7ns max, Input Impedance= 1 megohm.22pF.
2. Rise Time=10ns max, Source Impedance= 50 ohms.

Marking and packaging illustration

1、Marking

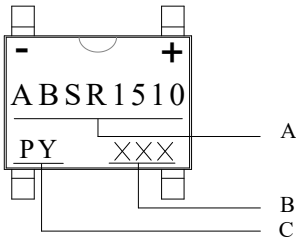

| SYMBOL | Explanation |
|----------|---------------------|
| A | Product Name |
| B | Date Code |
| C | Trademark |

2、Packaging

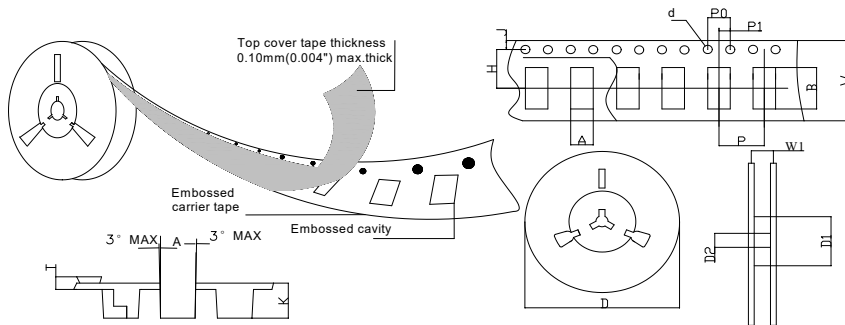

| SPECIFICATIONS mm(inch) | | PACKAGE | SPECIFICATIONS mm(inch) | | PACKAGE |
|----------------------------|------------|-----------------|----------------------------|------------|----------------|
| ITEM | SYM BOL | ABS | ITEM | SYM BOL | ABS |
| Carrier width | A | 5.45(0.215)Max | Carrier depth | K | 1.60(0.063)Typ |
| Carrier length | B | 7.0(0.276)Max | Punch hole pitch | P | 8.00(0.315)Typ |
| Sprocket hole | d | ø1.55(0.061)Typ | Sprocket hole pitch | P0 | 4.00(0.157)Typ |
| Reel outer diameter | D | 330.0(13.0)Typ | Embossment center | P1 | 2.00(0.079)Typ |
| Reel inner diameter | D1 | 50.0(2.913)Min | Overall tape thickness | T | 0.30(0.012)Typ |
| Feed hole diameter | D2 | 13.0(0.512)Typ | Tape width | W | 12.0(0.472)Typ |
| Sprocket hole position | J | 1.75(0.069)Typ | Reel width | W1 | 12.4(0.488)Min |
| Punch hole position | H | 5.50(0.217)Typ | | | |